



Printed in USA. Please recycle.

©2010 Ford Motor Company

<sup>1</sup>EPA-estimated 41 mpg city/36 hwy for 17.5-gallon tank. Actual mileage will vary. <sup>2</sup>Based on RDA Group's QORS cumulative survey at 3 months of service in 3 surveys of 2009 MY Ford and competitive owners conducted 9/08-5/09. <sup>3</sup>Based on NHTSA 5-Star ratings for all 4 crash test categories. 2011 model year to be tested. Star ratings are part of the U.S. Department of Transportation's Safercar.gov program (www.safercar.gov).

# 2011 ESCAPE+HYBRID



### Drive smart.

Our available radar-based active park assist practically parallel parks for you — in as little as 24 seconds.



### Drive green.

Up to 41 mpg city<sup>1</sup> means you can drive over 700 miles on a single tank in Fusion Hybrid.



### Drive quality.

Ford Motor Company is unsurpassed by Toyota and Honda when it comes to quality.<sup>2</sup>



### Drive safe.

Ford has the most NHTSA 5-Star safety ratings<sup>3</sup> of any company.



[fordvehicles.com](http://fordvehicles.com)

#### <Dealer Name>

<Dealer Street>

<Dealer City, State, ZIP>

Dealership: <(000) 000-0000>

Service: <(000) 000-0000>

<dealerwebsite.com>

#### Sales Hours

M	0:00 AM – 0:00 PM
Tu	0:00 AM – 0:00 PM
W	0:00 AM – 0:00 PM
Th	0:00 AM – 0:00 PM
F	0:00 AM – 0:00 PM
Sa	0:00 AM – 0:00 PM
Su	0:00 AM – 0:00 PM

#### Service Hours

M	0:00 AM – 0:00 PM
Tu	0:00 AM – 0:00 PM
W	0:00 AM – 0:00 PM
Th	0:00 AM – 0:00 PM
F	0:00 AM – 0:00 PM
Sa	0:00 AM – 0:00 PM
Su	0:00 AM – 0:00 PM

0000000-00000-11ESCCAT

Courtesy of <Dealer Name>



Drive one.

Fuel-sipping,  
fun-loving,  
adventure seekers.



**The New 2011 Escape+Hybrid – Presented by <Dealer Name>**

With up to **34 mpg city**, Escape Hybrid is the **most fuel-efficient SUV in America**.<sup>1</sup> The standard 2.5L I-4 engine on Escape gets **28 mpg hwy**.<sup>2</sup> Both offer the capability of available intelligent 4WD and tons of smart technology including our latest available **Ford SYNC**® voice-activated, in-vehicle connectivity system and available **active park assist**, which helps you parallel park in as little as 24 seconds, leaving you more time for adventure.

<sup>1</sup>EPA-estimated 34 city/31 hwy/32 combined mpg for Escape Hybrid FWD. Actual mileage will vary. Excluding vehicles built for Mazda. <sup>2</sup>EPA-estimated 23 city/28 hwy/25 combined mpg for Escape FWD with 2.5L I-4 and 5-speed manual; 21 city/28 hwy/23 combined mpg for Escape FWD with 2.5L I-4 and 6-speed automatic.

**Escape XLT in Sangria Red Metallic with available equipment**

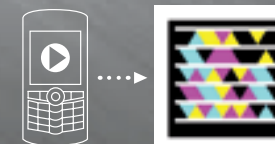

**SEE FEATURES COME TO LIFE**  
Simply download the free app at [gettag.mobi](http://gettag.mobi) or text **ESCAPE** to **4FORD**. Then follow the directions to snap a photo of this "tag" (shown left), and start learning more about Ford Escape right on your smart phone.

Standard text messaging and data rates apply.

## Escape Hybrid: the most fuel-efficient SUV in America.<sup>1</sup>

Seriously. Escape Hybrid gets up to **34 mpg** city and 31 hwy.<sup>1</sup> In fact, the powertrain is so self-sufficient, it actually **recharges itself**. The 2.5L I-4 Atkinson-cycle engine works with the electric traction motor to move you with **177 net horsepower**. When you apply the brakes during normal driving, the Regenerative Braking System captures kinetic energy from your braking to recharge the 330-volt battery pack. The battery pack then supplies energy to drive in **100% electric mode up to 44 mph**. When passing or merging, hybrid drive mode delivers an extra power boost for lively acceleration performance while still delivering lower average fuel costs. It's the best of both worlds.

<sup>1</sup>EPA-estimated 34 city/31 hwy/32 combined mpg for Escape Hybrid FWD. Actual mileage will vary. Excluding vehicles built for Mazda.

Escape Hybrid Limited in Lime Squeeze Metallic with available equipment



34 mpg city

## Intelligent 4WD gets you out there.

With fully independent suspensions and outstanding clearance, both Escape and Escape Hybrid are **naturally nimble** enough to drive up and over some formidable obstacles that some others will have to waste time driving around. If you prefer the road less traveled, go for the optional **intelligent 4WD**. Always on and always working, it automatically monitors traction 200 times per second (much faster than any person could) and adjusts torque distribution as needed to give you **maximum grip**. It's got serious skills.

Escape XLT in Ingot Silver Metallic with available equipment





## Active park assist is your street-side advantage.

**Quicker and more user-friendly** than a luxury brand's competitive system,<sup>1</sup> our available active park assist helps you **conquer parallel parking** in as little as **24 seconds**. Just press a button and drive by potential spots. Ultrasonic sensors help you find a spot that's big enough, and the system lets you know when it's ready to park. You remove your hands from the steering wheel and respond to system prompts by shifting gears and controlling vehicle speed with the brake and accelerator pedals. The system handles the hard part: **automatically steering the vehicle** into the spot. It's bound to be your new best friend.

<sup>1</sup>Based on head-to-head comparison of Ford Escape versus Lexus LS 460 L conducted by Ford Motor Company.

**Escape Limited in White Suede with available equipment**



## MyKey® encourages smart driving.

The industry-first, Ford-exclusive MyKey owner controls feature – standard on all models for 2011 – lets you assign **separate keys for additional drivers**, all coded to **enforce your specific restrictions** on vehicle functions like top speed and audio volume. When activated, MyKey encourages smart driving behavior by muting audio until safety belts are buckled, prohibiting the shutoff of key accident-avoidance features like AdvanceTrac® with RSC® (Roll Stability Control™), and more.



## Engines flex, tow, sip and go.

Escape's available **Duratec® 30-3.0L V6** engine is **Flex Fuel** capable, so you can run it on gasoline, E85 (85% ethanol and 15% gasoline), or any blend of the 2. Mated to an efficient 6-speed automatic transmission, it cranks out **240 horsepower** and tows up to **3,500 lbs.** when properly equipped.

Whether you pair it with the standard 5-speed manual transmission or the available 6-speed automatic, the standard **Duratec 25-2.5L I-4** engine delivers a remarkable **28 mpg hwy.**<sup>1</sup> It also supplies a spirited 171 horsepower and 171 lb.-ft. of torque.

Our industry-first **Easy Fuel® capless fuel filler**, standard on all models, automatically seals shut when you remove the fuel nozzle. There's no cap. So you just **gas up and go.** It also helps reduce evaporative emissions.

<sup>1</sup>Based on EPA-estimated 23 city/28 hwy/25 combined mpg for Escape FWD with 2.5L I-4 and 5-speed manual; 21 city/28 hwy/23 combined mpg for Escape FWD with 2.5L I-4 and 6-speed automatic.

Escape Limited in Tuxedo Black Metallic with available equipment





## SYNC. Say the word.

Voice-activated **Ford SYNC**® is an award-winning, available system that works with your paired Bluetooth®-enabled mobile phone and your digital media player. It provides hands-free calling, plays music, delivers Vehicle Health Reports and 911 Assist.™ With the touch of a button and voice commands, SYNC with **Traffic, Directions and Information** services provides turn-by-turn directions, personalized traffic alerts and more! [SyncMyRide.com](http://SyncMyRide.com) has the latest details.



## A truly illuminating experience.

The available **Navigation System** (shown) features a vibrant 6.5-in. LCD touch screen and colorful maps that you can zoom and scroll. This system plays DVDs while Escape is in Park and provides nearly 10 gigs of photo and music storage space. It also includes an introductory 6-month subscription to **SIRIUS Traffic**™ and **SIRIUS Travel Link**,™<sup>2</sup> which provides fuel prices, weather reports, movie listings, sports scores and more. All this, in addition to over 130 channels of SIRIUS® Satellite Radio.

<sup>1</sup>Driving while distracted can result in loss of vehicle control. Only use mobile phones and other devices, even with voice commands, when it is safe to do so. Traffic alerts and turn-by-turn directions available in select markets. Standard text messaging and data rates apply. <sup>2</sup>Some features unavailable while driving. Subscription required after introductory 6 months expire.

Escape Limited in Charcoal Black with available equipment



The use of environmentally friendly, **soy-based foam** in the seat cushions on every Escape model helps conserve limited resources and reduce CO<sub>2</sub> emissions. Escape Hybrid and XLT also feature **sustainable cloth-trimmed seating** made with 100% post-industrial materials – recycled plastics and polyester fibers that would otherwise have ended up in landfills.

### **Designed to support, comfort and shine.**

Escape is just the **right size** – inside and out. Its comfort-designed seats easily accommodate as many as **5 adults**. Supple leather-trimmed seating (shown above) with **heated front seats**, plus gleaming chrome and Ebony Black interior accents, are standard on Escape Limited and Hybrid Limited.

Escape Limited in Charcoal Black with available equipment





A



B



C



D



E

## Plenty of space for your latest challenge.

- A. With the rear seats folded flat, Escape delivers up to **67.2 cu. ft.** of wide-open space. And even with the seats up, you still get up to 31.4 cu. ft. of space to fill with everything you need.
- B. Inside the standard **floor console**: a 3-tier storage system, 2 removable bins, and a hidden storage area deep enough for a laptop or purse.
- C. Escape Hybrid is uniquely equipped with a **110-volt power outlet**.<sup>1</sup> Use it to charge your laptop, personal gaming system, or other portable electronics.
- D. This **hidden, lockable wet trunk** is perfect for keeping valuables out of sight. It's found in the available Cargo Package, along with a retractable cargo area cover and a 100-lb.-capacity roof rack.
- E. Tip-fold-flat latches make it easy to configure the standard **60/40 split-fold rear seats** to fit your immediate gear-hauling needs.

<sup>1</sup>See your owner's guide for complete details.

## Simply tops in safety. ★★★★★

The 2010 Escape and Escape Hybrid both received **5-Star ratings**<sup>1</sup> in the National Highway Traffic Safety Administration's (NHTSA) frontal and side-impact crash tests. This year, each comes equipped with a long list of cutting-edge safety features designed to help provide continued peace of mind. **1 – AdvanceTrac® with RSC® (Roll Stability Control™)** is the only electronic stability control system in the class that utilizes 2 gyroscopic sensors to help keep all 4 wheels firmly planted.<sup>2</sup> **2 – Personal Safety System™** features dual-stage front airbags for the driver and front passenger. **3 – Front-seat side airbags** increase protection for the driver and front passenger in certain side-impact collisions. **4 – Safety Canopy® System** includes side-curtain airbags and a rollover sensor. **5 – SOS Post-Crash Alert System™** flashes the hazard lights and sounds the horn after airbag deployment or safety belt pretensioner activation in certain collisions.<sup>3</sup> All standard. And those are just the highlights.

<sup>1</sup>2010 model year. 2011 model year to be tested. Star ratings are part of the U.S. Department of Transportation's Safercar.gov program ([www.safercar.gov](http://www.safercar.gov)). <sup>2</sup>Class is Small SUVs. Remember that even advanced technology cannot overcome the laws of physics. It's always possible to lose control of a vehicle due to inappropriate driver input for the conditions. <sup>3</sup>SOS hardware may become damaged or the battery may lose power in a crash, which could prevent operation. Not all crashes will activate an airbag or safety belt pretensioner.

Escape XLT in Sterling Gray Metallic with available equipment

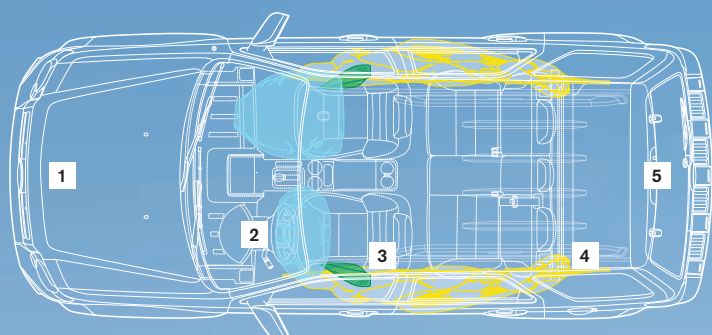



# XLS & XLT

## INTERIOR

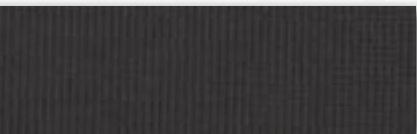

Graystone Cloth  
Standard on XLS

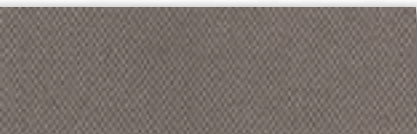

Premium Stone Cloth  
Standard on XLT

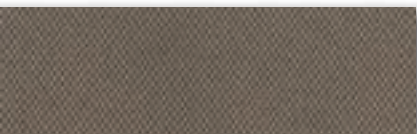

Premium Camel Cloth  
Standard on XLT



Charcoal Black Cloth  
Standard on XLT

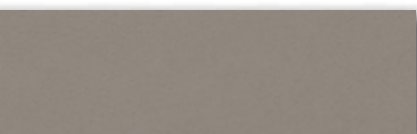

Stone Leather  
Optional on XLT (requires Leather Package)

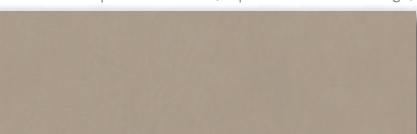

Camel Leather  
Optional on XLT (requires Leather Package)



Charcoal Black Leather  
Optional on XLT (requires Leather Package)



Escape XLT in Charcoal Black with Sport Appearance Package and other available equipment



Escape XLT in Ingot Silver Metallic with Sport Appearance Package and other available equipment

## OPTIONAL FEATURES

### XLS Available Rapid Spec

Rapid Spec 101A – 6-speed automatic transmission

Rapid Spec 102A – 6-speed automatic transmission + **Cargo Package** includes roof side rails with crossbars, retractable cargo area cover and lockable wet trunk

### XLS Available Options

Ford SYNC® voice-activated, in-vehicle connectivity system (n/a with Rapid Spec 100A)

Front and rear all-weather floor mats

Front and rear color-keyed carpeted floor mats

Intelligent 4WD (n/a with Rapid Spec 100A)

### XLS Exterior Colors

XLS Exterior Colors	Interior Color
White Suede	●
Sangria Red Metallic	●
Blue Flame Metallic	●
Gold Leaf Metallic	●
Steel Blue Metallic	●
Sterling Gray Metallic	●
Ingot Silver Metallic	●
Tuxedo Black Metallic	●

Interior: ● Graystone Cloth



16-in. Cast-Aluminum Wheels  
Standard on XLS and XLT



17-in. Chrome-Clad Aluminum Wheels  
Optional on XLT



17-in. Premium Black Wheels with Machined-Finish Outer Ring included with Sport Appearance Package on XLT

### XLT Available Rapid Spec

Rapid Spec 201A – **Sun & SYNC Package** includes power moonroof and Ford SYNC

Rapid Spec 202A – **Sun & SYNC Package + Cargo Package**

Rapid Spec 203A – **Sun & SYNC Package + Cargo Package + Leather Package** includes leather-trimmed seats, heated driver and front-passenger seats, and ambient lighting

### XLT Available Options & Packages

17-in. chrome-clad aluminum wheels with P225/65R17 all-season BSW tires (n/a with Sport Appearance Package)

### Cargo Package

Duratec® 30–3.0L V6 Flex Fuel engine

Ford SYNC in-vehicle connectivity system

Front and rear all-weather floor mats

Integrated side step bars (n/a with Sport Appearance Package)

Intelligent 4WD

### Leather Package<sup>1</sup>

Premium Sound System with single-CD player, clock and 7 speakers (including an 8-in. subwoofer) with 320 watts

**Sport Appearance Package** includes high-gloss Black grille, lower front appliqué, heated sideview mirrors and liftgate spoiler; Blacked-out headlamp treatment; 17-in. premium Black wheels with machined-finish outer ring and P225/65R17 all-season BSW tires; body-color door handles and rocker moldings; Charcoal Black cloth seating (Charcoal Black Leather when ordered with Leather Package); Ebony Black interior accents; chrome finish on interior door handles, air register bezels and shifter knob insert<sup>2</sup>

**Trailer Tow Prep Package** includes Class II 3,500-lb. receiver and trailer wiring harness with 4-pin connector (V6 only)

### XLT Exterior Colors

XLT Exterior Colors	Interior Colors
White Suede	● ● ● ● ●
Sangria Red Metallic	● ● ● ● ● ●
Blue Flame Metallic	● ● ● ● ● ●
Gold Leaf Metallic	● ● ● ● ● ●
Steel Blue Metallic	● ● ● ● ● ●
Sterling Gray Metallic	● ● ● ● ● ●
Ingot Silver Metallic	● ● ● ● ● ●
Tuxedo Black Metallic	● ● ● ● ● ●

Interiors: ● Premium Stone Cloth ● Premium Camel Cloth ● Charcoal Black Cloth ● Stone Leather ● Camel Leather ● Charcoal Black Leather

## EXTERIOR

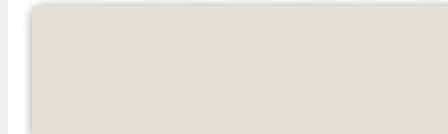

White Suede



Sangria Red Metallic



Blue Flame Metallic

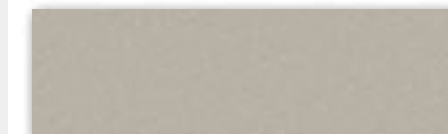

Gold Leaf Metallic

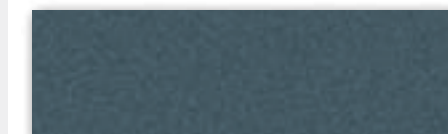

Steel Blue Metallic



Sterling Gray Metallic

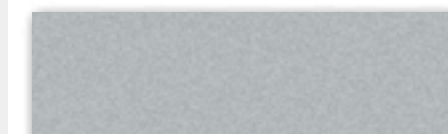

Ingot Silver Metallic



Tuxedo Black Metallic

Colors are representative only. See your dealer for actual paint/trim options.

<sup>1</sup>Requires Sport Appearance Package. <sup>2</sup>Available with Steel Blue Metallic, Ingot Silver Metallic, Sterling Gray Metallic or Tuxedo Black Metallic exterior colors. Includes roof side rails only when ordered with Cargo Package or Sun & SYNC Package. Not available with 17-in. chrome-clad wheels or integrated side step bars.

# LIMITED



Charcoal Black with available equipment



Tuxedo Black Metallic with available equipment

## OPTIONAL FEATURES

### Available Rapid Spec

Rapid Spec 301A – **Moon & Tune Package** includes power moonroof and Premium Sound System with single-CD player, clock and 7 speakers (including an 8-in. subwoofer) with 320 watts

Rapid Spec 302A – **Limited Luxury Package** includes dual-zone electronic automatic temperature control, Reverse Sensing System, rear view camera and universal garage door opener + **Moon & Tune Package**

### Available Options & Packages

17-in. chrome-clad aluminum wheels with P225/65R17 all-season BSW tires

Active park assist (available only with Rapid Spec 302A)

Duratec® 30-3.0L V6 Flex Fuel engine

Front and rear all-weather floor mats

Integrated side step bars

Intelligent 4WD

**Trailer Tow Prep Package** includes Class II 3,500-lb. receiver and trailer wiring harness with 4-pin connector (V6 only)

Voice-activated Navigation System with nearly 10-gigabyte hard drive, single-disc Premium Sound System, HD Radio™ technology and SIRIUS Traffic and SIRIUS Travel Link services with introductory 6-month subscription (n/a with Rapid Spec 300A)

### Exterior Colors

White Suede

Sangria Red Metallic

Gold Leaf Metallic

Steel Blue Metallic

Sterling Gray Metallic

Ingot Silver Metallic

Tuxedo Black Metallic

### Interior Colors

	■	■
	■	■
	■	■
	■	■
	■	■
	■	■
	■	■

**Interiors:** ■ Camel Leather ■ Charcoal Black Leather

### EXTERIOR

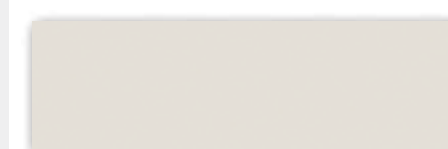

White Suede



Sangria Red Metallic

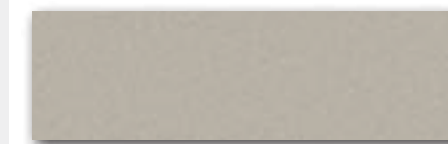

Gold Leaf Metallic

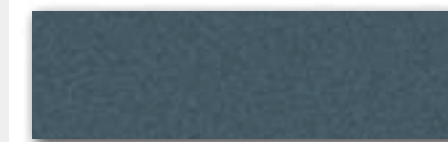

Steel Blue Metallic

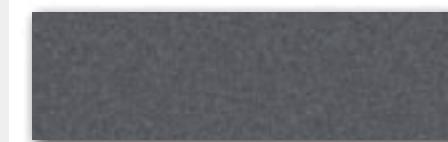

Sterling Gray Metallic

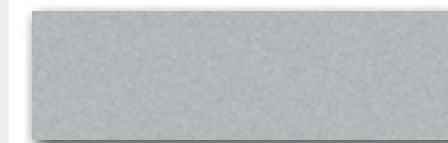

Ingot Silver Metallic

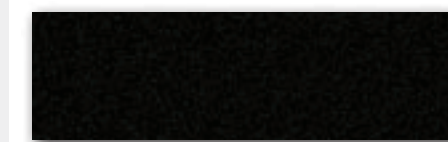

Tuxedo Black Metallic

### INTERIOR

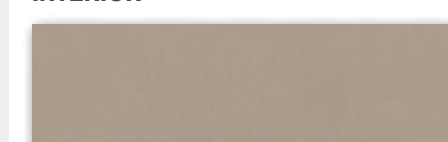

Camel Leather Standard

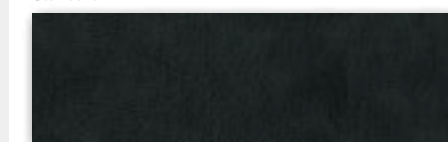

Charcoal Black Leather Standard



16-in. Bright-Machined Aluminum Wheels Standard



17-in. Chrome-Clad Aluminum Wheels Optional

Colors are representative only. See your dealer for actual paint/trim options.

# HYBRID & HYBRID LIMITED



Escape Hybrid Limited in Stone with available equipment



Escape Hybrid Limited in Steel Blue Metallic

## OPTIONAL FEATURES

### Hybrid Available Options & Packages

- Black roof-rail crossbars
- Integrated side step bars
- Intelligent 4WD
- Power moonroof with sunshade and mini-overhead console
- Voice-activated Navigation System with nearly 10-gigabyte hard drive, single-disc Premium Sound System, HD Radio™ technology, Hybrid Energy Flow and Power & Efficiency monitors, and SIRIUS Traffic and SIRIUS Travel Link services with introductory 6-month subscription

Hybrid Exterior Colors	Interior Color
White Suede	●
Lime Squeeze Metallic	●
Steel Blue Metallic	●
Ingot Silver Metallic	●
Tuxedo Black Metallic	●

Interior: ● Premium Stone Cloth

### Hybrid Limited Available Options & Packages

- Active park assist
- Integrated side step bars
- Intelligent 4WD
- Voice-activated Navigation System with nearly 10-gigabyte hard drive, single-disc Premium Sound System, HD Radio technology, Hybrid Energy Flow and Power & Efficiency monitors, and SIRIUS Traffic and SIRIUS Travel Link services with introductory 6-month subscription

Hybrid Limited Exterior Colors	Interior Color
White Suede	■
Lime Squeeze Metallic	■
Steel Blue Metallic	■
Ingot Silver Metallic	■
Tuxedo Black Metallic	■

Interior: ■ Stone Leather



16-in. Unique Cast-Aluminum Wheels  
Standard on Hybrid



16-in. Bright-Machined Aluminum Wheels  
Standard on Hybrid Limited

### EXTERIOR

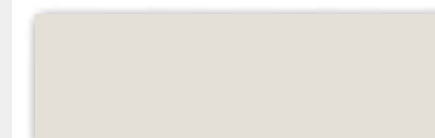

White Suede



Lime Squeeze Metallic



Steel Blue Metallic

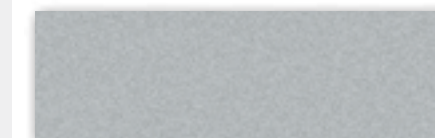

Ingot Silver Metallic



Tuxedo Black Metallic

### INTERIOR

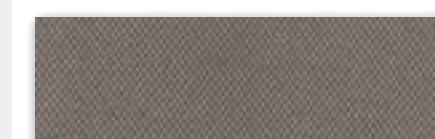

Premium Stone Cloth  
Standard on Hybrid

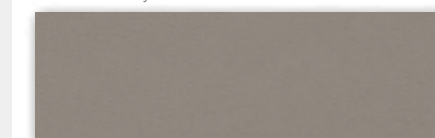

Stone Leather  
Standard on Hybrid Limited

Colors are representative only.  
See your dealer for actual paint/trim options.

## Escape your way.

- A. Brighten your drive with the available **power moonroof**. There's an optional **Sun & SYNC Package** on XLT that mixes it with the Ford SYNC® voice-activated, in-vehicle connectivity system. The optional **Moon & Tune Package** on Limited pairs it with a 320-watt, 7-speaker Premium Sound System that includes a single-CD player.
- B. See what's behind the vehicle when you're in Reverse with the available **rear view camera**. It displays the full-color image from its liftgate-mounted camera onto your rearview mirror or the available Navigation System's large LCD screen (shown).
- C. Conquer inclement weather with the available **heated sideview mirrors**. Just the touch of a button puts them on their way to clear while you stay comfortably indoors.
- D. Carry as much as 100 lbs. of cargo up top when you add **roof side rails with crossbars**. The optional **Cargo Package** on XLS and XLT offers them together with a retractable cargo area cover and a lockable wet trunk.
- E. Set the available **ambient lighting** to match your mood with 7 glowing options from red hot to cool blue.
- Listen to your favorite AM and FM channels in crystal-clear digital sound, courtesy of new **HD Radio™** technology included with the available Navigation System. It also gives you new local FM channels, on-screen information and much more – all 100% subscription-free.



A

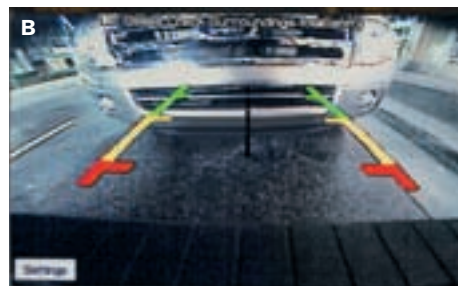

B



C



D



E

## Ford Custom Accessories

Also available:

### APPEARANCE

Ford Custom Graphics by Original Wraps™, Inc.<sup>1</sup>

### ELECTRONICS

Portable Navigation Systems by Garmin®<sup>1</sup>

Vehicle Security System

HitchScan™ Rear Park Assist Sensor and Hitch Step by EchoMaster®<sup>1</sup>

Forward or Reverse Parking Assist System by EchoMaster<sup>1</sup>

GPS Tracking and Recovery by SmartAlert™<sup>1</sup>

Keyless Entry Keypad

Wiper De-Icer and Debris Cleaner by Wiper Shaker<sup>1</sup>

### EXTERIOR

Roof Cross Bars

Hard Cargo Organizer

Molded Running Boards

Moonroof Deflector

Hood Deflector

Side Window Deflectors

Splash Guards

Locking Fuel Plug

Sportz® SUV Tents by Napier<sup>1</sup>

Trailer Hitch Balls/Drawbars<sup>2</sup>

Trailer Hitch Assembly<sup>2</sup>

Trailer Wiring Harness Kit<sup>2</sup>

### INTERIOR

Auto-Dimming Rearview Mirror

Cargo Area Protector

Interior Light Kit

Cargo Net

Cargo-Logic® System

Ash Cup/Coin Holder With or Without Lighter Element

### WHEELS

Wheel Locks



To learn more about Ford Custom Accessories and to shop online, visit [fordaccessories.com](http://fordaccessories.com).



Genuine Ford Accessories will be warranted for whichever provides you the greatest benefit: 12 months or 12,000 miles (whichever occurs first), or the remainder of your Bumper-to-Bumper 3-year/36,000-mile New Vehicle Limited Warranty. Contact your local Ford Dealer for details and a copy of the limited warranty. Ford Licensed Accessories (FLA) are warranted by the accessory manufacturer's warranty. Ford Licensed Accessories are fully designed and developed by the accessory manufacturer and have not been designed or tested to Ford Motor Company engineering requirements. Contact your Ford Dealer for details regarding the manufacturer's limited warranty and/or a copy of the FLA product limited warranty offered by the accessory manufacturer.

<sup>1</sup>Ford Licensed Accessories. <sup>2</sup>Not for use with Hybrid. THULE is a registered trademark of Thule Sweden AB. INVISION is a trademark of Audiovox Corporation. Garmin is a registered trademark of Garmin Ltd. SmartAlert is a registered trademark of Inilex, Inc. Cargo-Logic is a registered trademark of Lund, Inc.



Racks and Carriers by THULE®<sup>1</sup>



Dual Headrest DVD by INVISION™<sup>1</sup>



Remote Start Systems



Paintable Rear Roof Spoiler



Soft Cargo Organizers (Large and Standard Sizes) and Soft Cargo Cooler Bag



Cargo Security Shade



All-Weather Floor Mats

2011 Escape

**Drive one.**



We'll be standing by.

You, your family, your neighbors,  
your local Ford Dealer. We're all part  
of a broad community, connected  
by a far-reaching support structure  
that benefits us all. As a proud  
member of this network, your  
local Ford Dealer looks forward  
to assisting you — now, and in  
the future. Whether you're  
seeking a new or used vehicle,  
Ford Custom Accessories,  
or convenient maintenance and  
service, we're here for you.  
And we'll be by your side.

**Today.**

at <Dealer Name>

<Dealer Street>  
<Dealer City, State, ZIP>  
<(000) 000-0000>  
<dealerwebsite.com>